

**NEW:**  
The Chubb safes Europa provides the highest level of protection for cash and valuables to international standards



# Europa (Grades 3 & 5)

burglary protection

- Key Features**
- High quality cash safe protecting cash within an office environment with a high level of security of Grade 3 & 5
  - The Europa range is tested to ECBS 5 and conforming to EN1143-1
  - Passive and active relockers are incorporated into the boltwork to resist attack
  - Chubb safes special barrier material is applied in the construction of the safe to protect against varying kinds of burglary attack

- Each safe can be equipped with high quality fittings to maximise storage requirements
- The Europa can be customised with a choice of locking options, deposits, shelves and lockable drawer deposits in order to meet customer requirements
- Base fixing is standard on all models



Tested to conform to  
AS/NZS 3809 (Safes and Strongrooms)  
Licenc No: SMKHZ0290

**Chubb safes**  
Trusted the world over.

BURGLARY  
RESISTANCE

## Product Specifications

- All Chubb safes' locks are tested to VDS and conform to EN1143-1
- The Europa 3 & 5 offer Key Lock with keyless Combination locking as standard. A wide variety of electronic, time delay locks can be fitted on request.



Electronic lock

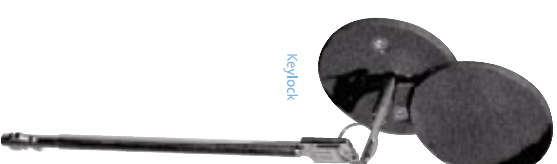

Keylock

## Internal Fittings

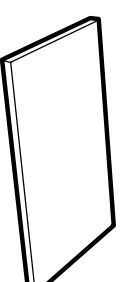
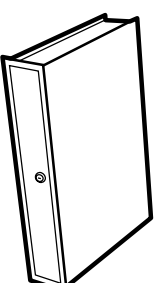
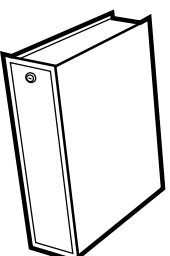

**Victoria**  
40 Stubb Street Kensington, Vic 3031  
Telephone: (03) 9372 5599 Fax: (03) 93725666  
Website: <http://www.safesupplies.com.au>  
Email: [blaney@safesupplies.com.au](mailto:blaney@safesupplies.com.au)

**AUSTRALIAN SAFE SUPPLIES**  
PROUDLY AUSTRALIAN OWNED AND MANUFACTURED

**South Australia**  
275 Grange Road, Findon SA 5023  
Telephone: (08) 8347 3399 Fax: (08) 8347 34009  
Website: <http://www.safesupplies.com.au>  
Email: [mroberts@safesupplies.com.au](mailto:mroberts@safesupplies.com.au)

Europa Dimensions

Grade	Size	External			Depth with door at 90°	Width for full access	Internal			Volume (L)	Net Weight (kg)
		Height (A)	Width (B)	Depth (C)			Height (D)	Width (E)	Depth (F)		
III	2	718	668	663	1277	1232	550	500	420	116	565
	3	1018	668	663	1277	1232	850	500	420	179	750
	4	1208	668	773	1387	1232	1040	500	530	276	1010
	5	1468	668	773	1387	1232	1300	500	530	345	1160
	6	1796	903	663	1510	1680	1628	735	420	503	1635
	7	1796	903	773	1620	1680	1628	735	530	634	1765
	V	2	730	680	663	1277	1227	588	538	444	140
	3	1030	680	663	1277	1227	888	538	444	212	873
	4	1220	680	773	1387	1227	1078	538	554	322	1107
	5	1480	680	773	1387	1227	1338	538	554	400	1287
	6	1808	915	663	1510	1697	1666	773	444	572	1840
	7	1808	915	773	1620	1697	1666	773	554	715	1968

Installation Guide

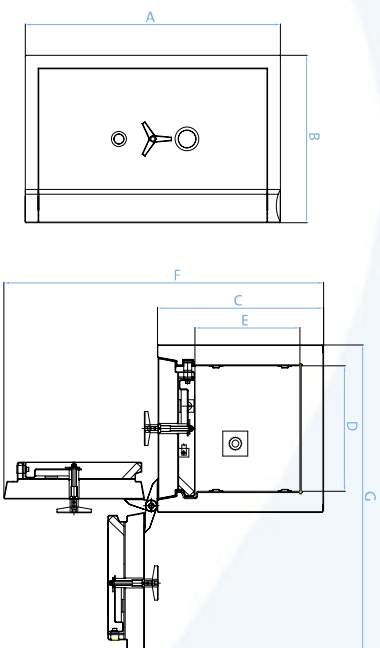

NB: Fire protection is only available on sizes in Grade III

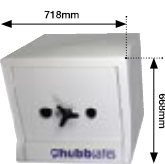
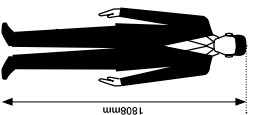

Size 2



Size 3

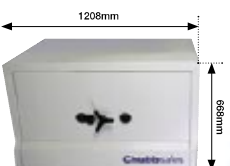

Size 4

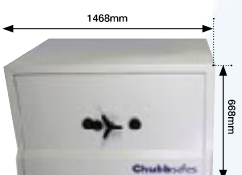

Size 5

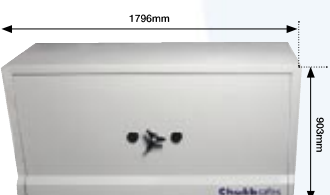

Size 6



Size 7

A range of attack tools are used in the testing of Chubb's Europa products from basic tools to the sophisticated tools like oxy-acetylene.

Please ask for further assistance on how we can customise your storage requirements for secure, convenient use.



- Inner compartment as specified by customers
- Prepared to accept pneumatic system for depositing

- Envelope slot with anti-fish device

- Drawer deposit front or rear

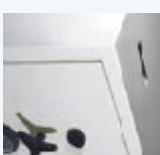

The Europa has been tested to the highest quality in its class against attack.